

03

0317

Circular connectors with threaded joint M16 acc. to IEC 61076-2-106, IP40/IP67/IP68



Chassis plug acc. to IEC 61076-2-106, IP 68, with threaded joint, for printed circuit boards, for back side mounting

03 0317

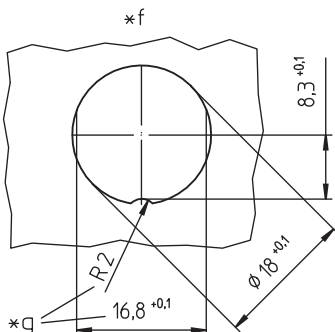
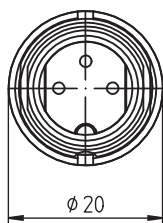
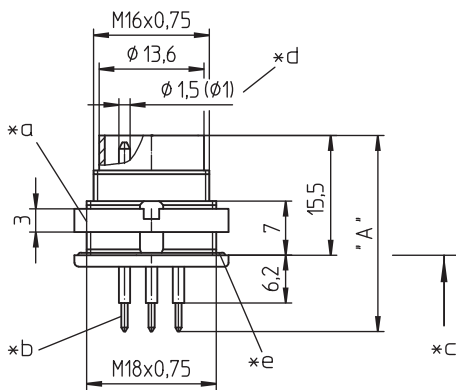
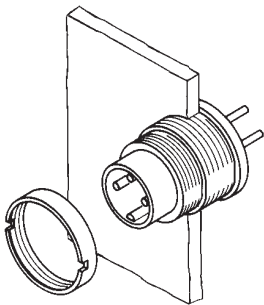

Environmental conditions

Temperature range -40 °C/+85 °C

Materials

Insulating body PA GF, V-0 according to UL94
 Contact pin CuZn, silver-plated and flash gold-plated, tin-plated in solder area (3-8 poles)
 CuZn, pre-nickel and gold-plated, tin-plated in solder area (12-14 poles)
 Housing Zn diecast, pre-copper and nickel-plated
 Ring screw CuZn, nickel-plated

Mechanical data

Protection class IP68¹

¹ according to IEC DIN EN 60529, only in locked condition with an appropriate counterpart; IPX8 requirements under agreement between manufacturer and user

Electrical data (at T_{amb} 20 °C)

Rated current 5 A (T_{amb} 40 °C, 3-8 poles)
 3 A (T_{amb} 40 °C, 12-14 poles)
 Rated voltage with pollution degree 1:
 300 V (versions 03, 04, 05-1, 06, 07)
 100 V (versions 05, 07-1, 08, 08-1)
 160 V (versions 12, 14)
 with pollution degree 2:
 250 V (versions 03, 04)
 32 V (versions 05, 07-1, 08, 08-1)
 160 V (versions 05-1, 06, 07, 12, 14)
 Rated impulse voltage 1500 V (versions 03, 04, 05-1, 06, 07, 12, 14)
 500 V (versions 05, 07-1, 08, 08-1)
 Material group II (IEC)/I (UL) (CTI ≥ 550)
 Overvoltage category I
 Insulation resistance > 100 MΩ

Associated products

Counterparts
 ☞ 0321 ☞ 0322 ☞ 0322-1
 ☞ 032200 ☞ 0360 ☞ 036000

Accessories
 ☞ 0383 ☞ 038399 ☞ 0384
 ☞ 0385 ☞ 038899

03

0317

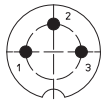

03-a
0317 03

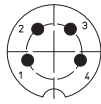

04-a
0317 04

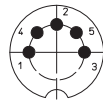

05-b
0317 05

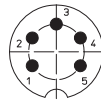

05-a
0317 05-1

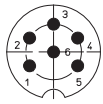

06-a
0317 06

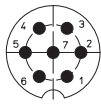

07-a
0317 07

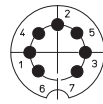

07-b
0317 07-1

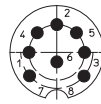

0317 08

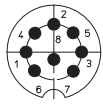

08-a
0317 08-1

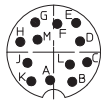

12-a
0317 12

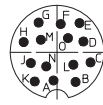

14-a
0317 14

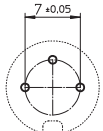

03-a
0317 03

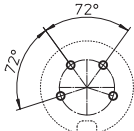

04-a
0317 04

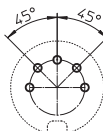

05-b
0317 05

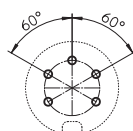

05-a
0317 05-1

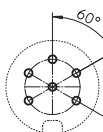

06-a
0317 06

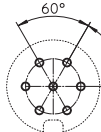

07-a
0317 07

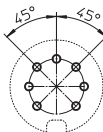

07-b
0317 07-1

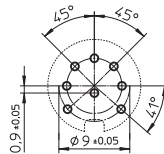

0317 08

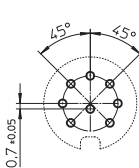

08-a
0317 08-1

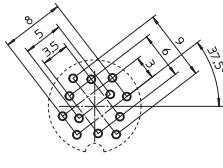

12-a
0317 12

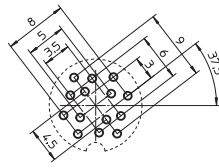

14-a
0317 14

03

0317

-
- *a nut enclosed separately
 - *b for bore hole of PCB
Ø 1,0 mm (0317 03–0317 08-1)
Ø 0,7 mm (0317 12–0317 14)
 - *c mounting direction
 - *d contact pin
Ø 1.5 mm (0317 03–0317 08-1)
Ø 1.0 mm (0317 12–0317 14)
 - *e O-ring gasket
 - *f port in mounting plate
 - *g anti-rotation, alternative execution

03

0317

Designation	Pole Number	PU (Pieces)	MDQ (Pieces)	Dimensions A (mm)
0317 03	3	50	100	25.4
0317 04	4	50	100	25.4
0317 05	5	50	100	25.4
0317 05-1	5	50	100	25.4
0317 06	6	50	100	25.4
0317 07	7	50	100	25.4
0317 07-1	7	50	100	25.4
0317 08	8	50	100	25.4
0317 08-1	8	50	100	25.4
0317 12	12	50	100	24.8
0317 14	14	50	100	24.8

Packaging:

in a cardboard box